

Dear **FORA V30** System Owner:

Thank you for purchasing the **FORA V30** Blood Glucose Monitoring System. This manual provides important information to help you to use the system properly. Before using this product, please read the following contents thoroughly and carefully.

Regular monitoring of your blood glucose levels can help you and your doctor gain better control of your diabetes. Due to its compact size and easy operation, you can use the **FORA V30** Blood Glucose Monitoring System to easily monitor your blood glucose levels by yourself anywhere, any time.

If you have other questions regarding this product, please contact the place of purchase.

IMPORTANT SAFTY INSTRUCTIONS

READ BEFORE USE

1. Use this device **ONLY** for the intended use described in this manual.
2. Do **NOT** use accessories which are not specified by the manufacturer.
3. Do **NOT** use the device if it is not working properly or if it is damaged.
4. Do **NOT** use the equipment in places where aerosol sprays are being used or where oxygen is being administered.
5. Do **NOT** under any circumstances use the device on newborns, infants, or people who cannot communicate.
6. This device does **NOT** serve as a cure for any symptoms or diseases. The data measured is for reference only. Always consult your doctor to have the results interpreted.

7. Before using this device to test blood glucose, read all instructions thoroughly and practice the test. Carry out all the quality control checks as directed.
8. Keep the device and testing equipment away from young children. Small items such as the battery cover, batteries, test strips, lancets and vial caps are choking hazards.
9. Use of this instrument in a dry environment, especially if synthetic materials are present (synthetic clothing, carpets etc.) may cause damaging static discharges that may cause erroneous results.
10. Do not use this instrument in close proximity to sources of strong electromagnetic radiation, as these may interfere with the accurate operation.

KEEP THESE INSTRUCTIONS IN A SAFE PLACE

TABLE OF CONTENTS

BEFORE YOU BEGIN	06
Important Information	06
Intended Use	07
Test Principle	07
Contents of System	08
Meter Overview	09
Display Screen	10
Test Strip	11
Speaking Function	12
Setting the Meter	13
THE FOUR MEASURING MODES	18
BEFORE TESTING	20
Control Solution Testing	20
Performing a Control Solution Test	21
TESTING WITH BLOOD SAMPLE	24
Preparing the Lancing Device for Blood Testing	24
Preparing the Puncture Site	25
Alternative Site Testing	27
Performing a Blood Glucose Test	29
METER MEMORY	32
Reviewing Test Results	32
Reviewing Blood Glucose Day Average Results	34
Downloading Results onto a Computer	37

MAINTENANCE	39
Battery	39
Caring for Your Meter	41
Caring for Your Test Strips	42
Important Control Solution Information	43
SYSTEM TROUBLESHOOTING	44
Result Readings	44
Error Messages	45
Troubleshooting	47
DETAILED INFORMATION	49
Reference Values	49
Comparing Meter and Laboratory Results	50
SYMBOL INFORMATION	52
SPECIFICATIONS	53

BEFORE YOU BEGIN

Important Information

- Severe dehydration and excessive water loss may cause readings which are lower than actual values. If you believe you are suffering from severe dehydration, consult a healthcare professional immediately.
- If your blood glucose results are lower or higher than usual, and you do not have any symptoms of illness, first repeat the test. If you have symptoms or continue to get results which are higher or lower than usual, follow the treatment advice of your healthcare professional.
- Use only fresh whole blood samples to test your blood glucose. Using other substances will lead to incorrect results.
- If you are experiencing symptoms that are inconsistent with your blood glucose test results and you have followed all the instructions given in this owner's manual, contact your healthcare professional.
- We do not recommend using this product on severely hypotensive individuals or patients in shock. Readings which are lower than actual values may occur for individuals experiencing a hyperglycaemic-hyperosmolar state, with or without ketosis. Please consult the healthcare professional before use.

Intended Use

This system is intended for use outside the body (*in vitro* diagnostic use) by people with diabetes at home and by health care professionals in clinical settings as an aid to monitoring the effectiveness of diabetes control. It is intended to be used for the quantitative measurement of glucose (sugar) in fresh whole blood samples (from the finger, palm, forearm, upper arm, calf and thigh).

It should not be used for the diagnosis of diabetes, or testing on newborns

Test Principle

Your system measures the amount of sugar (glucose) in whole blood. The glucose testing is based on the measurement of electrical current generated by the reaction of glucose with the reagent of the strip. The meter measures the current, calculates the blood glucose level, and displays the result. The strength of the current produced by the reaction depends on the amount of glucose in the blood sample.

Contents of System

Your new **FORA V30** system kit includes:

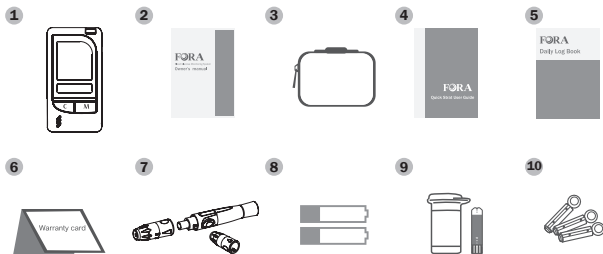

- | | |
|--------------------------|-------------------------------------|
| 1 Meter | 6 Warranty Card |
| 2 Owner's Manual | 7 Lancing Device with One Clear Cap |
| 3 Protective Wallet | 8 2X1.5V AAA alkaline batteries |
| 4 Quick Start User Guide | 9 Test Strips |
| 5 Daily Log Book | 10 Sterile Lancets |

NOTE

All items can be purchased separately and some accessories may not be included in the kit. If you wish to purchase any accessories, please contact our local customer service.

Meter Overview

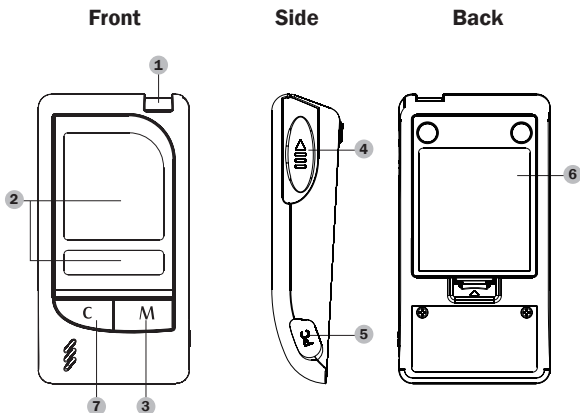

1 Test Slot

Insert test strip here to turn the meter on for testing.

2 Display Screen

3 M Button

Enter the meter memory and silence a reminder alarm.

4 Test Strip Ejector

Eject the used strip by pushing up this button.

5 Data Port

Download test results with a cable connection.

6 SET Button

Enter and confirm the meter settings.

7 C Button

Calibrates the meter and marks a control solution test.

Display Screen

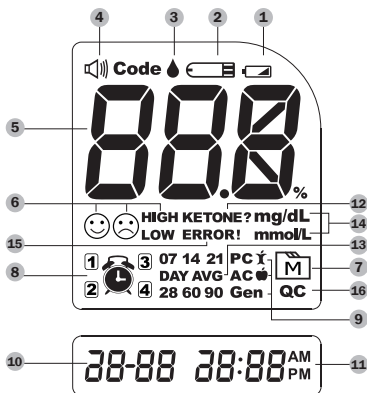

- | | |
|----------------------------|--------------------------|
| 1 Low Battery Symbol | 9 Measuring Mode |
| 2 Test Strip Symbol | 10 Date |
| 3 Blood Drop Symbol | 11 Time |
| 4 Volume Symbol | 12 Ketone Warning |
| 5 Test Result | 13 Day Average |
| 6 Face/Low/High Symbol | 14 Measurement Unit |
| 7 Memory Symbol | 15 Error Message |
| 8 Alarm Function Indicator | 16 Control Solution Mode |

Test Strip



1 Absorbent Hole

Apply a drop of blood here.

The blood will be automatically absorbed.

2 Confirmation Window

This is where you confirm if enough blood has been

applied to the absorbent hole in the strip.

3 Test Strip Handle

Hold this part to insert the test strip into the slot.

4 Contact Bars

Insert this end of the test strip into the meter. Push it in firmly until it will go no further.

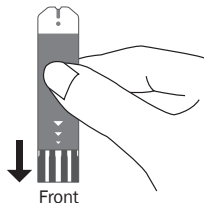

ATTENTION:

The front side of test strip with FORA Logo should face up when inserting test strip.

Test results might be wrong if the contact bar is not **fully** inserted into the test slot.

NOTE

The **FORA V30** meter should only be used with **FORA V30** Test Strips. Using other test strips with this meter can produce inaccurate results.

Speaking Function

FORA V30 “speaks” aloud step by step instructions to guide you through the process of blood glucose testing. The following table tells you when and what the meter “speaks”.

WHEN does the meter say?	WHAT does the meter say?
When turning on the meter.	Thank you for using this product. Please relax during measurement.
When room temperature is outside operating range, which is 10°C to 40°C (50°F to 104°F).	Room temperature out of range, unable to measure.
After inserting test strip.	Please apply blood onto the test strip.
When the meter is ready to test. (Symbol appears on display)	
When the test is completed. (Result appears on display)	The blood glucose is (number) milligrams per decilitre.
When the test result is outside measurement range, which is 20 to 600 mg/dL (1.1 to 33.3 mmol/L).	The blood glucose is out of range, unable to measure.

Setting the Meter

Before using your meter for the first time or if you change the meter battery, you should check and update these settings. Make sure you complete the steps below and have your desired settings saved.

► Entering the Setting Mode.

Start with the meter off (no test strip inserted). Press SET to turn on the meter.

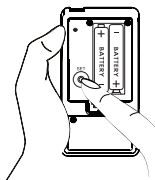

Step 1

Setting the date.

With the year flashing, press **M** until the correct year appears. Press SET.

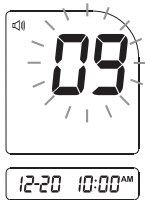

With the month flashing, press **M** until the correct month appears. Press SET.



With the day flashing, press **M** until the correct day appears. Press SET.



Step 2

Setting the time format.

Press and release **M** to select the desired time format — 12h or 24h. Press SET.

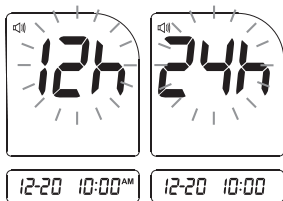

Step 3

Setting the time.

With the hour flashing, press **M** until the correct hour appears. Press SET.





With the minute flashing, press **M** until the correct minute appears. Press SET.



Step 4

Deleting the memory.

With “dEL” and “” symbol on the display, press  and select “no” to keep the results in memory then press SET to skip.

To delete all the results, press  and select “YES”.

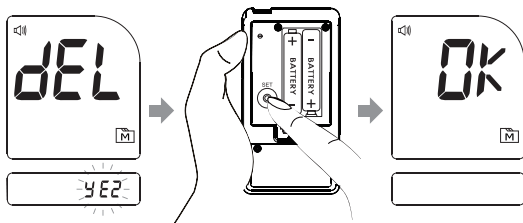

Then press SET to delete all memory. “OK” is displayed in the meter, which indicates that all data stored is deleted.



Step 5

Setting the Speaking Volume.

There are seven (7) speaking volume options to choose from. Press  to choose a volume from 0 to 7. To confirm your selection, press SET.

Volume 0 indicates that the speaking function is turned off, and “” will not display during testing. Volume 1 to 7 indicates speaking volume from low to high, and “” will be displayed throughout the testing.



Step 6

Choosing a Language.

Press **M** to select L1/L2. The default language for the meter is L1, which is English. To confirm your selection, press SET.

Step 7

Setting the reminder alarm.

You may set up any or all of the reminder alarms (1-4). The meter displays “On” or “OFF” and “”, press **M** to turn on or turn off to set the first reminder alarm.

Press **M** to select “On”, then press SET to set the hour. When the hour is flashing, press **M** to add an hour. Press SET to confirm and go to minutes, press **M** to add one minute. Hold **M** longer to add faster. Press SET to confirm and go to the next alarm setting.

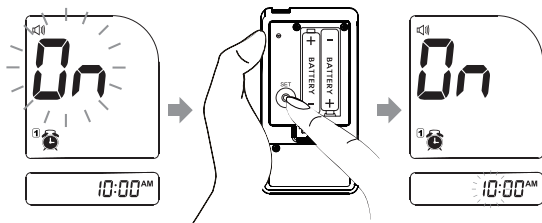

If you do not want to set an alarm, press SET to skip this step.

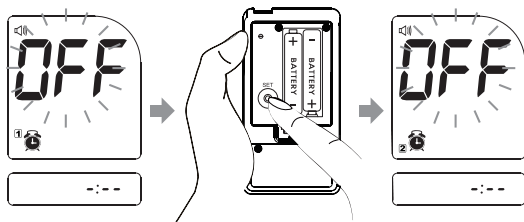

If you want to turn off an alarm, find the alarm number by pressing SET in the setting mode, press **M** to change from “ON” to “OFF”.

At the time of your alarm, the meter will beep and automatically turn on. You can press **M** to silence the alarm and insert a test strip to begin testing. If you do not press **M**, the meter will beep for 2 minutes then switch off. If you do not want to test at this time, press **M** to switch off the meter.

Press SET to turn off the meter. The meter repeats all your settings before shutdown.

Congratulations! You have completed all settings!

NOTE

- These parameters can **ONLY be changed** in the setting mode.
- If the meter is idle for 3 minutes during the setting mode, it will switch off automatically.

THE FOUR MEASURING MODES

The meter provides you with four modes for measuring, General, AC, PC and QC.

MODES	USE WHEN
Gen	any time of day without regard to time since last meal
AC 🍏	no food intake for at least 8 hours
PC 🍷	2 hours after a meal
QC	testing with the control solution

You can switch between each mode by:

Step 1

Start with the meter switched off.
Insert a test strip to turn on the meter.
The screen will display a flashing blood drop and "Gen".

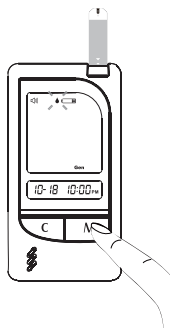

Step 2

Press **M** to switch between General, AC, and PC mode.

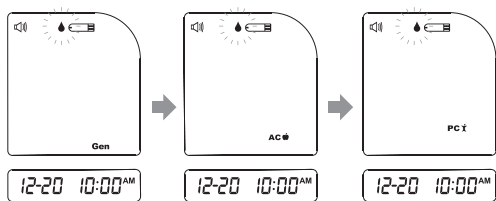

Step 3

Press **C** to switch to QC mode.

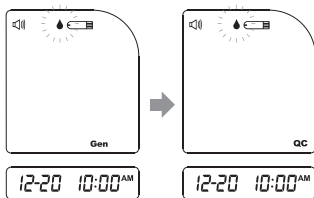

BEFORE TESTING

Control Solution Testing

FORA Control Solution contains a known amount of glucose that reacts with test strips and is used to ensure your meter and test strips are working together correctly.

Do a control solution test when:

- you first receive the meter,
- at least once a week to routinely check the meter and test strips,
- you begin using a new vial of test strips,
- you suspect the meter or test strips are not working properly,
- your blood glucose test results are not consistent with how you feel, or if you think the results are not accurate,
- practicing the testing process, or
- you have dropped or think you may have damaged the meter.

Performing a Control Solution Test

Step 1

Insert the test strip to turn on the meter.

Insert the test strip into the meter. Wait for the meter to display the test strip and blood drop symbols.

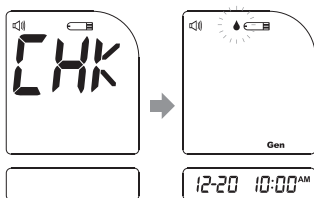

Step 2

Press **C** to mark this test as a control solution test.

If you press **C** again, the “QC” will disappear and this test is no longer a control solution test.

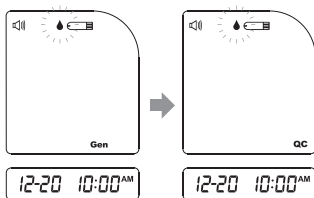

Step 3

Apply control solution.

Shake the control solution vial thoroughly before use. Squeeze out a drop and wipe it off, then squeeze out another drop and place it on the tip of the vial cap.

Hold the meter to move the absorbent hole of the test strip to touch the drop. Once the confirmation window fills completely, the meter will begin counting down.

To avoid contaminating the control solution do not directly apply control solution onto a strip.

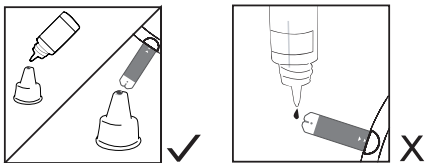

Step 4

Read and compare the result.

After counting down to 0, the control solution test result will appear on the display. Compare this result with the range printed on the test strip vial and it should fall within this range. If not, please read the instructions again and repeat the control solution test.

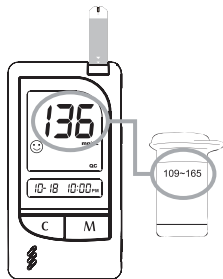

Out-of-range results.

If you continue to have test results fall outside the range printed on the test strip vial, the meter and strips may not be working properly.

Do NOT test your blood. Contact the local customer service or place of purchase for help.

NOTE

- The control solution range printed on the test strip vial is for control solution use only. It is not a recommended range for your blood glucose level.
- See the **Meter Maintenance** section for important information about your control solutions.

TESTING WITH BLOOD SAMPLE

NOTE

To reduce the chance of infection:

- Never share a lancet or the lancing device.
- Always use a new, sterile lancet. Lancets are for single use only.
- Avoid getting hand lotion, oils, dirt, or debris in or on the lancets and the lancing device.

Preparing the Lancing Device for Blood Testing

Please follow the instructions in the lancing device insert for collecting a blood sample.

Preparing the Puncture Site

Stimulating blood perfusion by rubbing the puncture site before blood extraction has a significant influence on the glucose value obtained. Blood from a site that has not been rubbed exhibits a measurably different glucose concentration than blood from the finger. When the puncture site was rubbed prior to blood extraction, the difference was significantly reduced.

Please follow the suggestions below before obtaining a drop of blood:

- Wash and dry your hands before starting.
- Select the puncture site either at fingertips or another body parts (please see section “Alternative Site Testing” (AST) on how to select the appropriate sites).
- Clean the puncture site using cotton moistened with 70% alcohol and let it air dry.
- Rub the puncture site for about 20 seconds before penetration.
- Use a clear cap (included in the kit) while setting up the lancing device.

► Fingertip Testing

Press the lancing device's tip firmly against the lower side of your fingertip. Press the release button to prick your finger, then a click indicates that the puncture is complete.

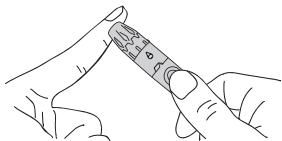

► Blood from Sites Other Than the Fingertip

Replace the lancing device cap with the clear cap for AST. Pull the cocking control back until it clicks. When lancing the forearm, upper arm, hand, thigh, or calf, avoid lancing the areas with obvious veins because of excessive bleeding.

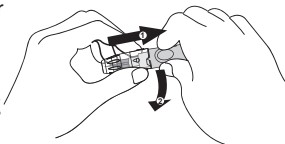

NOTE

- Choose a different spot each time you test. Repeated punctures at the same spot may cause soreness and calluses.
- Please consult your health care professional before you begin AST.
- It is recommended to discard the first drop of blood as it might contain tissue fluid, which may affect the test result.

Alternative Site Testing

Important: There are limitations with AST (Alternative Site Testing). Please consult your health care professional before you perform AST.

What is AST?

Alternative site testing (AST) means that people use parts of the body other than the fingertips to check their blood glucose levels. This system allows you to test on the palm, the forearm, the upper arm, the calf or the thigh with results equivalent to fingertip testing.

What is the advantage?

Fingertips feel pain more readily because they are full of nerve endings (receptors). At other body sites, since nerve endings are not so condensed, you will not feel as much pain as on the fingertips.

When to use AST?

Food, medication, illness, stress and exercise can affect blood glucose levels. Capillary blood at the fingertip reflects these changes faster than capillary blood at other sites. Thus, when testing blood glucose during or immediately after a meal, physical exercise, or any other event, **take a blood sample from your finger only.**

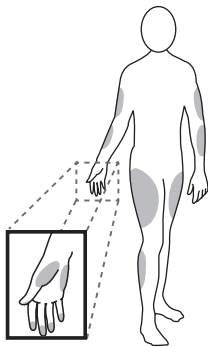

We strongly recommend that you perform AST **ONLY** at the following times:

- In a pre-meal or fasting state (more than 2 hours since the last meal).
- Two hours or more after taking insulin.
- Two hours or more after exercise.



Do **NOT** use AST if:

- You think your blood glucose is low.
- You are unaware of hypoglycemia
- You are testing for hyperglycemia
- Your AST results do not match the way you feel.
- Your routine glucose results are often fluctuate.

Performing a Blood Glucose Test

Step 1

Insert the test strip to turn on the meter.

Wait for the meter to display the test strip “” and blood drop “” symbol.

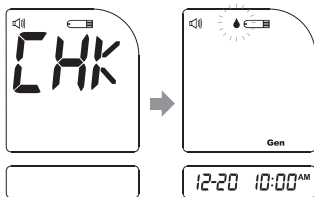

Step 2

Select the appropriate measuring mode by pressing .

For selecting the measuring mode, please refer to the “FOUR MEASURING MODES” section on page 18.

Step 3

Obtaining a blood sample.

Use the pre-set lancing device to puncture the desired site. After penetration, discard the first drop of blood with a clean cotton swab. Gently squeeze the punctured area to obtain another drop of blood. Be careful **NOT** to smear the blood sample.

The volume of blood sample must be at least 0.5 microliter (μL) of volume. ( actual size).

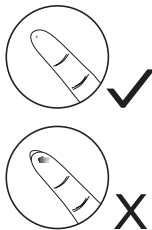

Step 4

Apply the sample.

Hold the blood drop to touch the absorbent hole of the test strip. Blood will be drawn in and after the confirmation window is completely filled, the meter begins counting down.

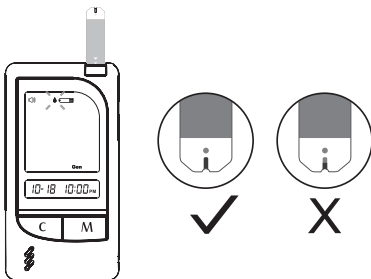

NOTE

- Do not press the punctured site against the test strip or try to smear the blood.
- If you do not apply a blood sample to the test strip within 3 minutes, the meter will automatically turn off. You must remove and reinsert the test strip to start a new test.
- The confirmation window should be filled with blood before the meter begins to count down. **NEVER** try to add more blood to the test strip after the drop of blood has moved away. **Discard the used test strip and retest with a new one.**
- If you have trouble filling the confirmation window, please contact your health care professional or the local customer service for assistance.

Step 5

Read your result.

The result of your blood glucose test will appear after the meter counts down to 0. This blood glucose result will automatically be stored in the memory.

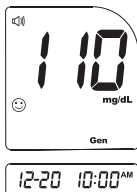

Step 6

Eject the used test strip and remove the lancet.

To eject the test strip, point the strip at a disposal container for sharp items. The meter will switch itself off automatically after the test strip is ejected.

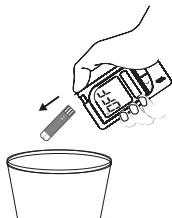

Step 7

Always follow the instructions in the lancing device insert when removing the lancet.

WARNING!

The used lancet and test strip may be biohazards. Please discard them carefully according to your local regulations.

METER MEMORY

The meter stores the 450 most recent blood glucose test results along with respective dates and times in its memory. To enter the meter memory, start with the meter switched off.

Reviewing Test Results

Step 1

Press **M**.

“**M**” will appear on the display. Press **M** again, and the first reading you see is the last blood glucose result along with date, time and the measuring mode.

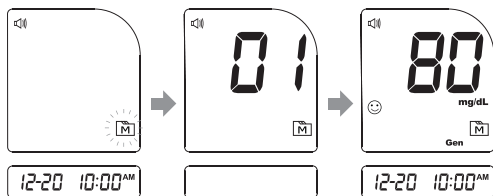

Step 2

Press **M** to recall the test results stored in the meter each time you press.

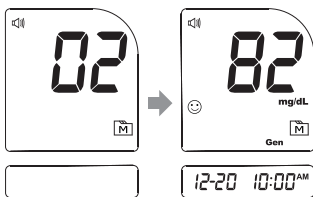

Step 3

Exit the meter memory.

After the last test results, press **M** again and the meter will be turned off.

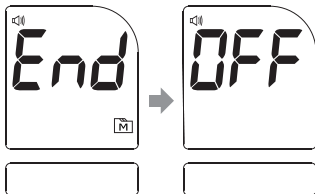

Reviewing Blood Glucose Day Average Results

Step 1

Press **M**.

When “**M**” appears on the display, keep pressing **M** for 3 seconds until the flashing “**DAY AVG**” appears. Release **M** and then your 7-day average result measured in general mode will appear on the display.

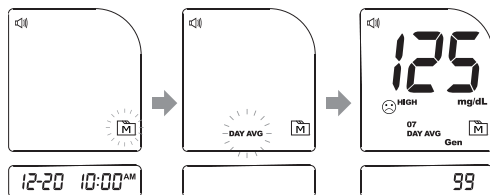

Step 2

Press **M** to review 14-, 21-, 28-, 60- and 90- day average results stored in each measuring mode in the order of Gen, AC, then PC.

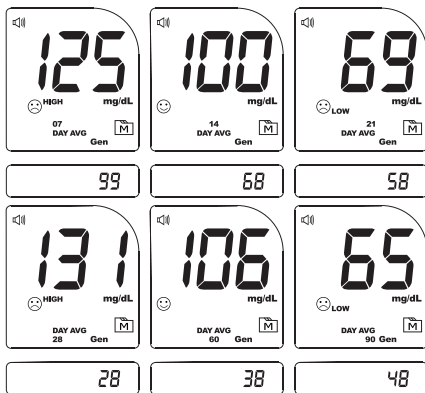

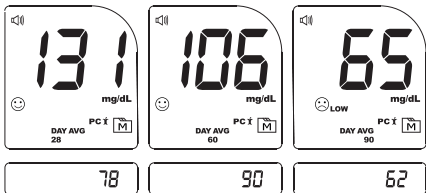
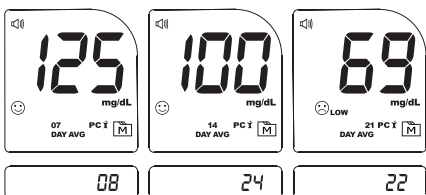
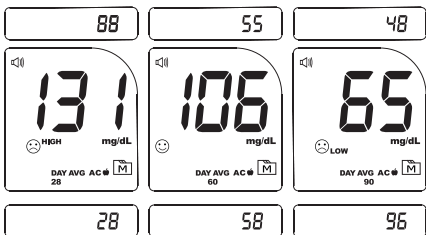

Step 3

Exit the meter memory.

Keep pressing **M** and the meter will turn off after displaying the last test result.

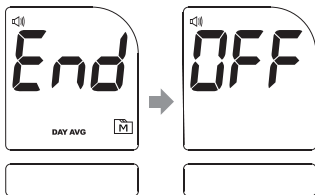

NOTE

- Any time you wish to exit the memory, keep pressing **M** for 5 seconds or leave it without any action for 3 minutes. The meter will switch off automatically.
- Control solution results are NOT included in the day average.
- If using the meter for the first time, “—” displays when you recall the test results or review the average result. It indicates that there is no test result in the memory.

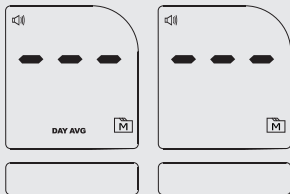

Downloading Results onto a Computer

Data Transmission Via Cable

You can use the meter with an interface cable and the Health Care Software System to view your test results on your personal computer. To learn more about the Health Care Software System or to obtain an interface cable separately, please contact local customer services or the place of purchase for assistance.

Step 1

Obtaining the required cable and installing the software.

To download the Health Care Software System, please visit the ForaCare Suisse AG, website at www.foracare.ch.

Step 2

Connecting to a personal computer.

Connect the cable to a USB port on your computer. With the meter switched off, connect the other end of the interface cable to the meter data port. "PC" will appear on the meter display, indicating that the meter is in communication mode.

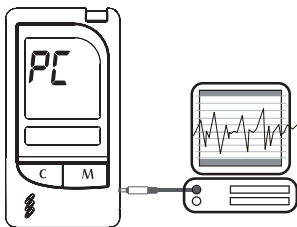

Step 3

Data transmission.

To transmit data, follow the instructions provided with the software. Results will be transmitted with date and time. Remove the cable and the meter will automatically switch off.

WARNING!

While the meter is connecting to the PC, it will be unable to perform a blood glucose test.

MAINTENANCE

Battery

Your meter comes with two 1.5V AAA size alkaline batteries.

► Low Battery Signal

The “” symbol appears along with display messages: The meter is functional and the result remains accurate, but it is time to change the battery.

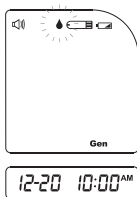

The “” symbol appears with **E-b, Error and low:**

The power is not enough to do a test.
Please change the battery immediately.

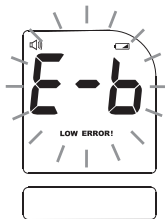

► Replacing the Battery

To replace the battery, make sure that the meter is turned off.

Step 1

Press the edge of the battery cover and lift it up to remove.

Step 2

Remove the old batteries and replace with two 1.5V AAA alkaline batteries.

Step 3

Close the battery cover. If the batteries are inserted correctly, you will hear a “beep” afterwards.

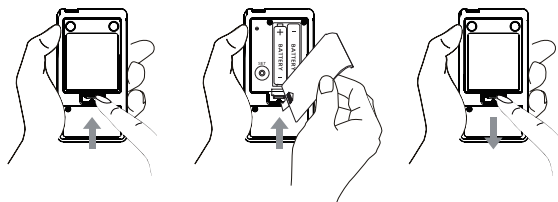

NOTE

- Replacing the batteries does not affect the test results stored in the memory.
- As with all small batteries, these batteries should be kept away from small children. If swallowed, promptly seek medical assistance.
- Batteries might leak chemicals if unused for a long time. Remove the batteries if you are not going to use the device for an extended period (i.e., 3 months or more).
- Properly dispose of the battery according to your local environmental regulations.

Caring for Your Meter

To avoid the meter and test strips attracting dirt, dust or other contaminants, please wash and dry your hands thoroughly before use.

► **Cleaning**

- To clean the meter exterior, wipe it with a cloth moistened with tap water or a mild cleaning agent, then dry the device with a soft and dry cloth. Do **NOT** rinse with water.
- Do **NOT** use organic solvents to clean the meter.

► **Meter Storage**

- Storage conditions: -20 °C to 60 °C (-4 °F to 140 °F), below 95% relative humidity.
- Always store or transport the meter in its original storage case.
- Avoid dropping and heavy impact.
- Avoid direct sunlight and high humidity.

Caring for Your Test Strips

- Storage conditions: 4 °C to 40 °C (39.2 °F to 104 °F), below 85% relative humidity. Do **NOT** freeze.
- Store your test strips in their original vial only. Do not transfer to another container.
- Store test strip packages in a cool and dry place. Keep away from direct sunlight and heat.
- After removing a test strip from the vial, immediately close the vial cap tightly.
- Touch the test strip with clean and dry hands.
- Use each test strip immediately after removing it from the vial.
- Write the opening date on the vial label when you first opened it. Discard remaining test strips after 3 months.
- Do not use test strips beyond the expiry date. This may cause inaccurate results.
- Do not bend, cut, or alter a test strip in any way.
- Keep the strip vial away from children since the cap and the test strip may be a choking hazard. If swallowed, promptly see a doctor for help.

For further information, please refer to the test strip package insert.







Important Control Solution Information

- Use only FORA control solutions with your meter.
- Do not use the control solution beyond the expiry date or 3 months after first opening. Write the opening date on the control solution vial and discard the remaining solution after 3 months.
- It is recommended that the control solution test be done at room temperature (20°C to 25°C / 68°F to 77°F). Make sure your control solution, meter, and test strips are at this specified temperature range before testing.
- Shake the vial before use, discard the first drop of control solution, and wipe off the dispenser tip to ensure a pure sample and an accurate result.
- Store the control solution tightly closed at temperatures between 2°C and 30°C (35.6°F and 86°F). Do **NOT** freeze.





SYSTEM TROUBLESHOOTING

If you follow the recommended action but the problem persists, or error messages other than the ones below appear, please call your local customer service. Do not attempt to repair by yourself and never try to disassemble the meter under any circumstances.

Result Readings

APPEARS	WHEN GLUCOSE		
Lo	< 20 mg/dL (1.1mmol/L)		
 LOW	20–69 mg/dL (1.1–3.8 mmol/L)		
	AC 	PC 	Gen
	70-129 mg/dL (3.9-7.2 mmol/L)	70-179 mg/dL (3.9-9.9 mmol/L)	70-119 mg/dL (3.9-6.6 mmol/L)
 HIGH	AC 	PC 	Gen
	130-239 mg/dL (7.2-13.3 mmol/L)	180-239 mg/dL (9.9-13.3 mmol/L)	120-239 mg/dL (6.7-13.3 mmol/L)
H_i	≥ 240 mg/dL (13.3 mmol/L)		
KETONE?	> 600 mg/dL (33.3mmol/L)		

Error Messages

MESSAGE	WHAT DOES METER SAY?	WHAT IT MEANS	WHAT TO DO
	<p>Battery is dead. Please replace.</p>	<p>Appears when the batteries cannot provide enough power for a test.</p>	<p>Replace the batteries immediately.</p>
	<p>Test strip has been removed during testing.</p>	<p>Remove the strip after applying blood to the absorbent hole.</p>	<p>Re-test with a new test strip.</p>
	<p>The test strip has been used. Please replace.</p>	<p>Appears when a used test strip is inserted.</p>	<p>Repeat with a new test strip.</p>
	<p>Room temperature is out of range. Thus unable to measure.</p>	<p>Appears when ambient temperature is below system operation range.</p>	<p>System operation range is 10°C to 40°C (50°F to 104°F). Repeat the test after the meter and test strip are in the above temperature range.</p>
		<p>Appears when ambient temperature is above system operation range.</p>	

MESSAGE	WHAT DOES METER SAY?	WHAT IT MEANS	WHAT TO DO
	<p>System error.</p>	<p>Problem with the meter.</p>	<p>Repeat the test with a new test strip. If the meter still does not work, please contact the customer service for assistance.</p>

Troubleshooting

1. If the meter does not display a message after inserting a test strip:

POSSIBLE CAUSE	WHAT TO DO
Batteries exhausted.	Replace the batteries.
Test strip inserted upside down or incompletely.	Insert the test strip with contact bars end first and facing up.
Defective meter or test strips.	Please contact customer services.

2. If the test does not start after applying the sample:

POSSIBLE CAUSE	WHAT TO DO
Insufficient blood sample.	Repeat the test using a new test strip with larger volume of blood sample.
Defective test strip.	Repeat the test with a new test strip.
Sample applied after automatic switch-off (2 minutes after last user action).	Repeat the test with a new test strip. Apply sample only when flashing “  ” appears on the display.
Defective meter.	Please contact customer services.

3. If the control solution testing result is out of range:

POSSIBLE CAUSE	WHAT TO DO
Error in performing the test.	Read instructions thoroughly and repeat the test again.
Control solution vial was poorly shaken.	Shake the control solution vigorously and repeat the test again.
Expired or contaminated control solution.	Check the expiry date of the control solution.
Control solution that is too warm or too cold.	Control solution, meter, and test strips should be at room temperature (20 °C to 25 °C / 68 °F to 77 °F) before testing.
Defective test strip.	Repeat the test with a new test strip.
Meter malfunction.	Please contact customer services.

DETAILED INFORMATION

Reference Values

Blood glucose monitoring plays an important role in diabetes control. A long-term study showed that maintaining **blood glucose levels close to normal** can reduce the risk of diabetes complications by up to 60%*¹. The results provided by this system can help you and your healthcare professional monitor and adjust your treatment plan to gain better control of your diabetes.

Time of day	Normal plasma glucose range for people without diabetes (mg/dL)
Fasting and before meal	< 100 mg/dL (5.6 mmol/L)
2 hours after meals	< 140 mg/dL (7.8 mmol/L)

Source: American Diabetes Association (2010). Clinical Practice Recommendations. Diabetes Care, 33 (Supplement 1): S1-100.

Please consult your doctor to determine a target range that works best for you.

References:

*1: American Diabetes Association position statement on the Diabetes Control and Complications Trial (1993).

Comparing Meter and Laboratory Results

The meter provides you with plasma equivalent results. The result you obtain from your meter may differ somewhat from your laboratory result due to normal variation. Meter results may be affected by factors and conditions that do not affect laboratory results in the same way. To make an accurate comparison between meter and laboratory results, follow the guidelines below

Before going to the lab:

- Perform a control solution test to make sure that the meter is working properly.
- Fast for at least eight hours before doing comparison tests, if possible.
- Take your meter with you to the lab.

While staying at the lab:

Make sure that the samples for both tests are taken and tested within 15 minutes of each other.

- Wash your hands before obtaining a blood sample.
- Never use your meter with blood that has been collected in a gray-top test tube.
- Use fresh capillary blood only.















You may still have a variation from the result because blood glucose levels can change significantly over short periods of time, especially if you have recently eaten, exercised, taken medication or experienced stress^{*2}. In addition, if you have eaten recently, the blood glucose level from a finger prick can be up to 70 mg/dL (3.9 mmol/L) higher than blood drawn from a vein (venous sample) used for a lab test^{*3}. Therefore, it is best to fast for eight hours before doing comparison tests. Factors such as the amount of red blood cells in the blood (a high or low hematocrit) or the loss of body fluid (dehydration) may also cause a meter result to be different from a laboratory result.

References:

*2: Surwit, R.S., and Feinglos, M.N.: Diabetes Forecast (1988), April, 49-51.

*3: Sacks, D.B.: "Carbohydrates." Burtis, C.A., and Ashwood, E.R.(ed.), Tietz Textbook of Clinical Chemistry. Philadelphia: W.B. Saunders Company (1994), 959.

SYMBOL INFORMATION

SYMBOL	REFERENT
	In vitro diagnostic medical device
	Do not reuse
	Consult instructions for use
	Keep away from sunlight
	Keep dry
	Temperature limitation
	Use by / Expiry date
	Batch code
	Manufacturer
SN	Serial number
	Caution, consult accompanying documents
	Do not use if package is damaged
	Use within 3 months after opening
	Sterilised using irradiation
	CE Mark

SPECIFICATIONS

Model No.: FORA V30

Dimension & Weight: 96(L) x 50(W) x 23(H) mm, 76.15g

Power Source: two 1.5V size AAA alkaline batteries

Display: LCD

Memory: 450 measurement results with respective date and time

External Output: RS232 PC interface

Auto electrode insertion detection

Auto sample loading detection

Auto reaction time count-down

Auto switch-off after 3 minutes without action

Temperature Warning

Operating Conditions:

10°C to 40°C, below 85% R.H. (non-condensing)

Storage / Transportation Condition:

-20°C to 60°C, below 95% R.H.

Measurement Units: mg/dL

Measurement Range: 20 to 600mg/dL (1.1 to 33.3mmol/L)

This device has been tested to meet the electrical and safety requirements of: IEC/EN 61010-1, IEC/EN 61010-2-101, IEC/EN 61326-1, IEC/EN 61326-2-6

MEMO

MEMO

MEMO